

**THE RESULT MUST AGREE –  
BUS-TECHNOLOGY MADE BY DEUTSCHMANN!**

# UNIGATE® IC

**Integrate the Fieldbus into your device  
without much development effort involved!**

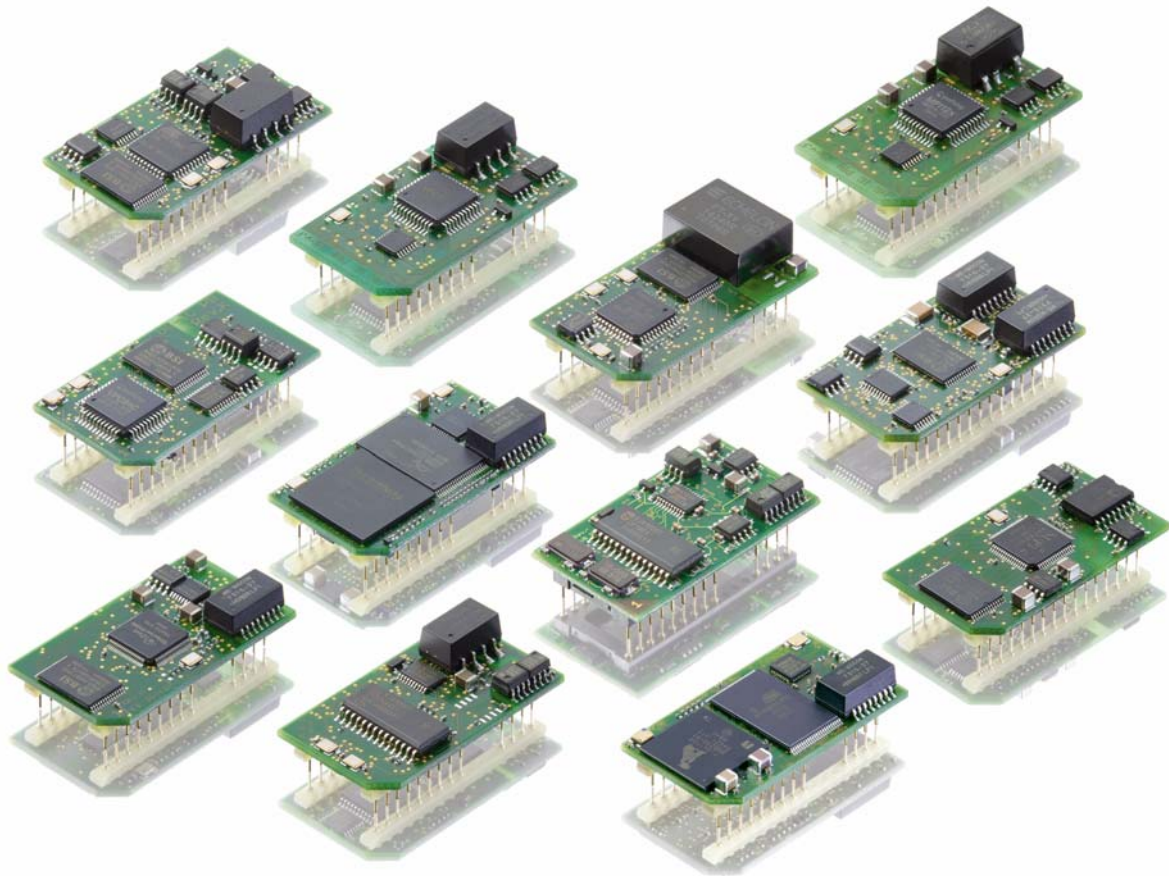

**All-in-one single bus nodes for:**



**Deutschmann Automation**

CANopen

DeviceNet

EtherCAT

EtherNet/IP

ETHERNET POWERLINK

ETHERNET TCP/IP

LONWorks

MODBUS ASCII

MODBUS RTU

MODBUS TCP

MPI

PROFIBUS

PROFIBUS INDUSTRIAL ETHERNET

RS 232  
RS 485/422

RK512

3964R

# The intelligent all-in-one bus node UNIGATE® IC

**UNIGATE IC combines all analog and digital signals of the Fieldbus- or Ethernet-interface on a small space of 45 x 25 mm (DIL-32-housing).**

The Deutschmann UNIGATE® IC is a complete singlechip bus-solution in a 32-DIL-housing. On a space of 45 x 25 mm only, the device contains all necessary components, such as microcontrollers, Flash, RAM, bus-chip and of course the analog components, such as optocoupler and bus driver. The UNIGATE® IC is connected to the microprocessor of the terminal equipment or it can be operated stand-alone. UNIGATE® ICs are certified and/or tested on the bus and through numerous applications, the problem-free operation with all marketable master systems has been proven.

The integrated microprocessor processes the entire data traffic with the bus and consequently relieves the terminal equipment processor of this considerable effort. The protocol of the terminal equipment is converted via a Script in the UNIGATE® IC.

With the free PC-tool "Protocol Developer" this Script is generated and optimally adapted to the final product and the requirements of the bus. Changes in the Firmware of the terminal equipment are not necessary and the microprocessor of the terminal equipment is not additionally loaded with communication- and bus-tasks.

The hard- and software-interfaces of the Deutschmann UNIGATE® IC-series are standardized and functionally identical. As a result, the exchangeability between the different UNIGATE® IC-versions is guaranteed.



## UNIGATE® IC Hardware overview

### Application

Deutschmann UNIGATE® IC is especially suitable for the use with terminal equipment from automatic control. Here it does not matter whether it is a complex control or a simple actuator or sensor. Of course with UNIGATE® IC control components beyond the classic automation technology can also be connected to the Fieldbus world or to buses based on Ethernet.

### Scope of functions

Deutschmann UNIGATE® IC uses the full data capacity of the respective bus and supports all speeds of the respective bus-version. The entire range of services of the respective bus (Slave) is supported by the UNIGATE®. A bus-ID can either be adjusted via the integrated shift register-interface with additionally mounted switch, the bus itself or the Script. Accessibility of LEDs for signaling the device status occurs via the shift register-interface or directly via the Fieldbus ASIC. The special advantage of the UNIGATE® IC-series is the Script-ability.

As a result, all changes at the Firmware of the terminal equipment are dropped. Through the Script the customer has all liberties and possibilities, from a simple, transparent data transfer over the generation of complex protocols to data editing.

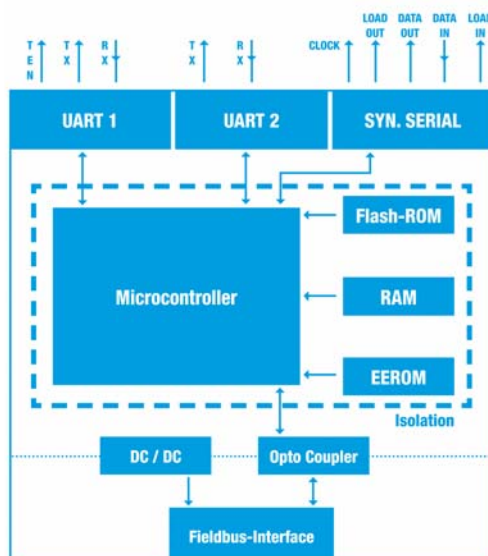

## Processor connection

In case UNIGATE® IC is used in systems with own microprocessor, it is connected to the processor of the final product via an UART interface. The UNIGATE® IC takes on the complete communication part including the bus-side and as a result it relieves the device processor of this considerable effort. The communication between the device processor and UNIGATE® IC is controlled by the Script. Through the Script technology it is possible to reproduce complex protocols, data can be processed, buffered between, charged, etc. And the Firmware of the terminal equipment is not touched.

## Stand-alone-operation

The connection to terminal equipment without processor can be carried out via the clocked shift register-interface (synchronous-serial interface). Up to 256 signals can be processed in each case for input and output. The Firmware of the UNIGATE® IC is responsible for the different number of input- and output-signals and it takes on control for this.

## Debug interface

The second serial interface of the UNIGATE® IC can be used as Debug-interface for testing a Script.

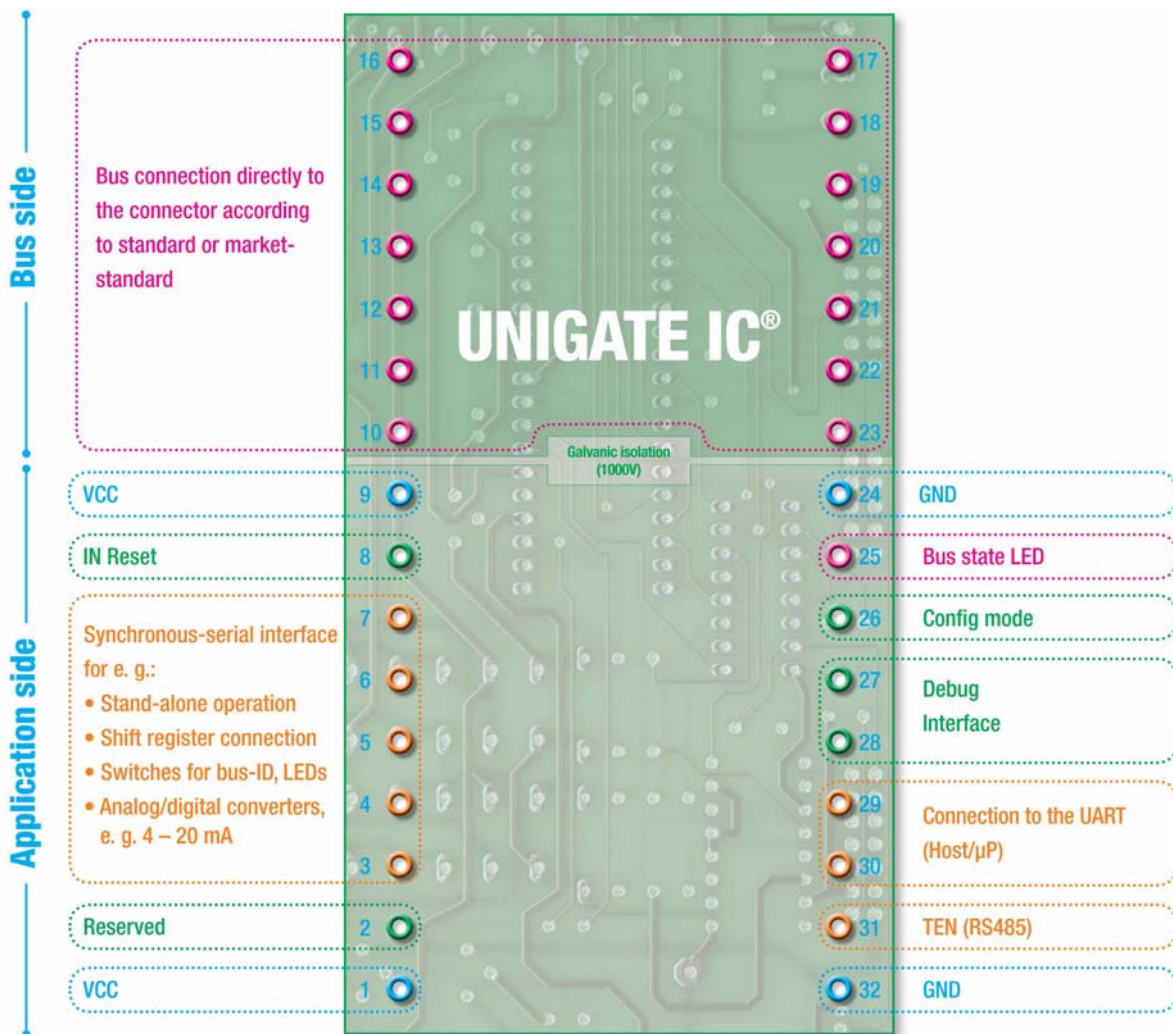

## Your advantage:

By using the Deutschmann UNIGATE® IC-modules the development effort is reduced by estimated 70 to 80% and valuable time for market launch is saved. On account of the continuity of the Deutschmann UNIGATE® IC-series not only one bus is implemented with a single change of your electronic system, but rather the entire Fieldbus selection offered by Deutschmann as well as the offered buses based on Ethernet offered by Deutschmann are available. Also the Script that has been generated once can practically be used without changes on the other Fieldbus- and Ethernet-based versions of the UNIGATE® IC-series. An adaptation of your own terminal equipment firmware is dropped.

CANopen

DeviceNet

EtherCAT

EtherNet/IP

ETHERNET POWERLINK

ETHERNET TCP/IP

LONWorks

MODBUS ASCII

MODBUS RTU

MODBUS TCP

MPI

PROFIBUS

PROFINET

RS 232  
RS 485/422

RK512

3964R

## Application example

Integrate UNIGATE® IC directly into your electronics!

The two pictures show customers' solutions for the integration of the bus.

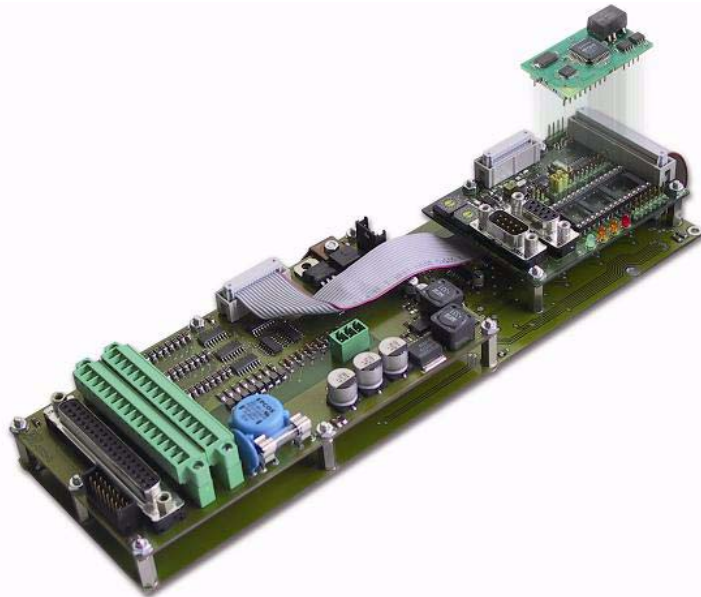

Customized  
adapter board for  
all UNIGATE® IC-versions  
produced by Deutschmann.

Example for an industrial keypad.  
If required INTERBUS as well as Profibus can be made available through the adapter board.

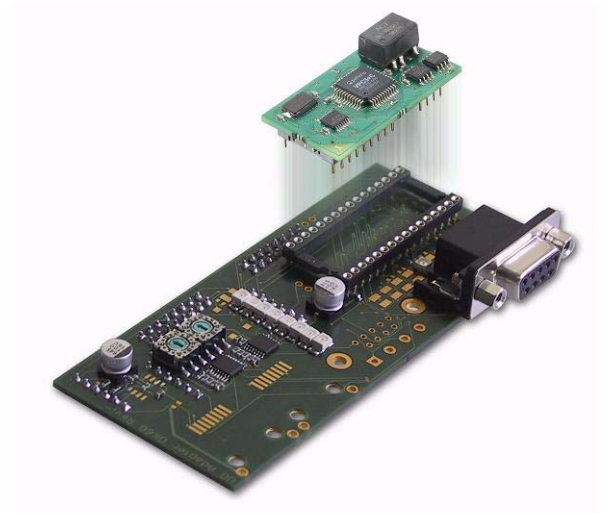

### Facts that speak for the UNIGATE® ICs by Deutschmann:

- Assembly consists of standard components
- Connection to the host processor via a UART-interface
- Expandable via synchronous-serial interface for instance for
  - Stand-alone operation (applications without processors)
  - Shift register connection
  - Switches for bus-ID, LEDs
  - Analog/digital converters, e. g. 4-20mA
- Simple integration into your electronic system
- All required components are included in the IC
- Integrated potential separation and optocoupler
- With one development only the most important Fieldbuses and Industrial Ethernet are being covered



Small dimensions:  
25 mm x 45 mm (W x H)

# Protocol Developer

## Our customers are looking for flexible solutions: With good reason.

You are rather inflexible with the usual configuration tools for Protocol Converters and Gateways and you have to stick to standard specifications. Adapting the Firmware to a certain protocol or observing a fixed way of proceeding is unwanted or too extensive, particularly in case of an existing software. Subsequent changes and customized adaptations are hardly possible. A profound knowledge of the buses is partially expected.

For that reason the Deutschmann Script language came into being in the year 1999 already. Our customer only has to process the data of the bus and he does not have to take care of the specific features of the Fieldbuses and Industrial Ethernet buses. For this programming he does not have to possess knowledge of programming languages, but he generates a Script by means of a Windows-tool 'PROTOCOL DEVELOPER'.

## What is a Script?

A Script is a sequence of commands, that are executed in that exact order. Because of the fact that also mechanisms are given that control the program flow in the Script it is also possible to assemble more complex processes from these simple commands. The Deutschmann Script language is strongly based upon tools, such as C++. In case you do not want to generate the Script yourself, we are also offering this service.

## What can be done with a Script device?

Our Script devices are in the position to process a lot of commands. In this case a command is always a small firmly outlined task. All commands can be put into classes or groups. A group of commands deals with the communication in general. This group's commands enable the Gateway to send and receive data on the serial side as well as on the bus-side.

Following please find the explanation of some command groups on the left side of the adjacent example window:

<b>Declarations</b>	Variable declaration
<b>FlowControl</b>	Subfunction calls, jumps, branches
<b>Math</b>	Mathematical functions
<b>Data conversions</b>	Communication Send and receive data
<b>Device control</b>	Set and read parameters. Exemplary the baud rate for the serial interface is mentioned here.
<b>Bus specific</b>	Here the commands are placed that enter bus-specific values.

The amount of tasks, that can be processed with a Script is virtually unlimited. Scripts, that are conceivable:

- automatically acquire data from one participant at the serial interface, edit this data and then present the edited data in the bus over and over again
- carry out actions only in case the bus data changes
- carry out time-controlled actions
- inform of communication states
- exchange data between 2 serial participants (RS485) and present the state in the bus

By means of this short enumeration it becomes clear that the Scripts are a flexible solution for your problems. Data can be processed, converted and arranged on both sides (on the RS-side and the bus-side as well). That way the Script basically offers the chance to cope with almost all requirements.

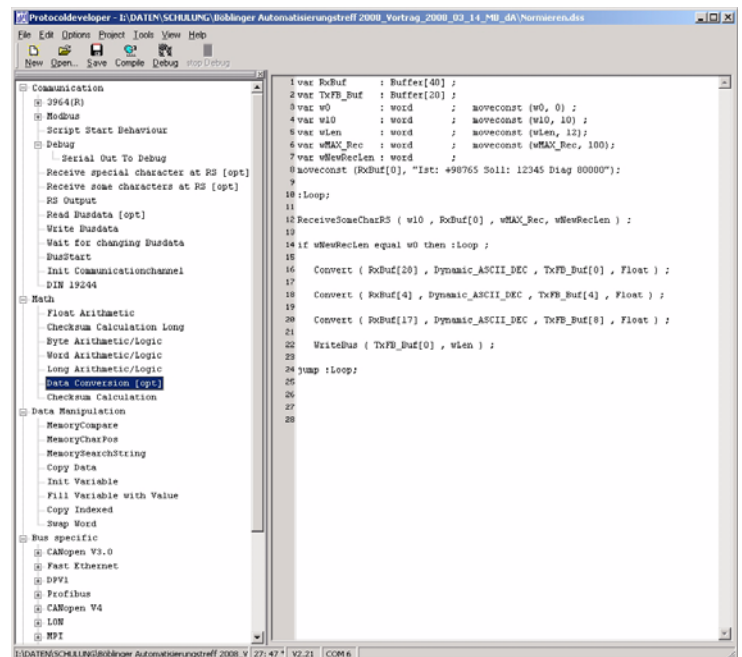

Picture 1: Protocol Developer main window

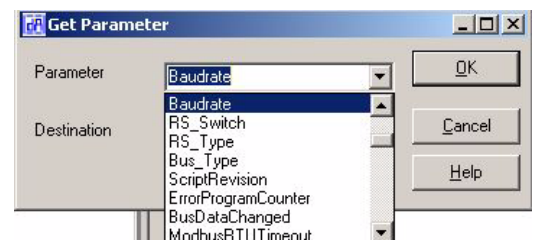

Picture 2: Function selection window

CANopen

DeviceNet

EtherCAT

EtherNet/IP

ETHERNET POWERLINK

ETHERNET TCP/IP

LONWorks

MODBUS ASCII

MODBUS RTU

MODBUS TCP

MPI

PROFIBUS

PROFIBUS INDUSTRIAL ETHERNET NET

RS 232  
RS 485/422

RK512

3964R

## The use of the Protocol Developer

On the right side of the window (picture 1) you see a Script, that shows the simple structure of the syntax.

The Protocol Developer is meant as a tool for an easy generation of a Script for our Script Gateways. Its operation is exactly aimed at this use.

Typical for Windows Script commands can be added by means of the mouse or the keyboard. As far as defined and required for the corresponding command, the dialog to the corresponding command is displayed, and after entering the values the right text is automatically added to the Script.

## Compiling

After the Script was generated it is compiled. The resulting code is loaded into the device afterwards. This can be carried out with the PROTOCOL DEVELOPER. A Script download tool is also available. The compiled code is very small and because of the large Script memory of the UNIGATE® products also extensive Scripts are possible.

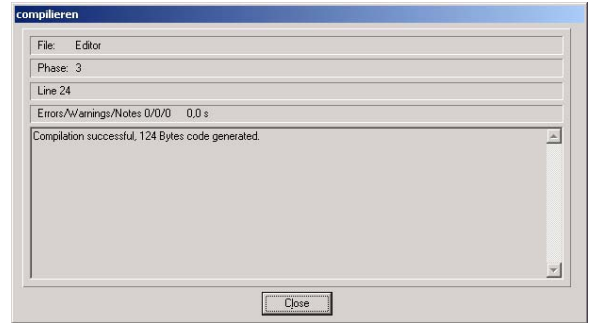

Picture 3: Compilation window with error message and file size

## Debugging

The Debugger enables the control of a UNIGATE® Gateway that is in the Debug-mode. For convenient Debugging further functions, such as

- Break point
- Single-step
- Display of the variables and their values
- Error indication

are made available. That way also extensive Scripts can be checked quickly.

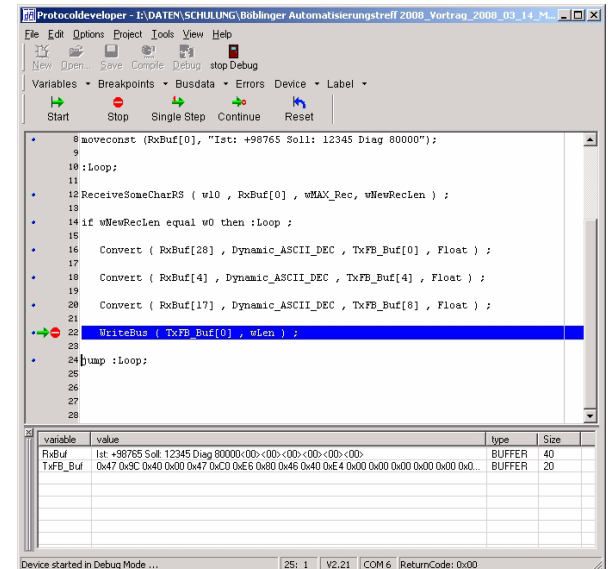

Picture 4: Debug window with variables and their content

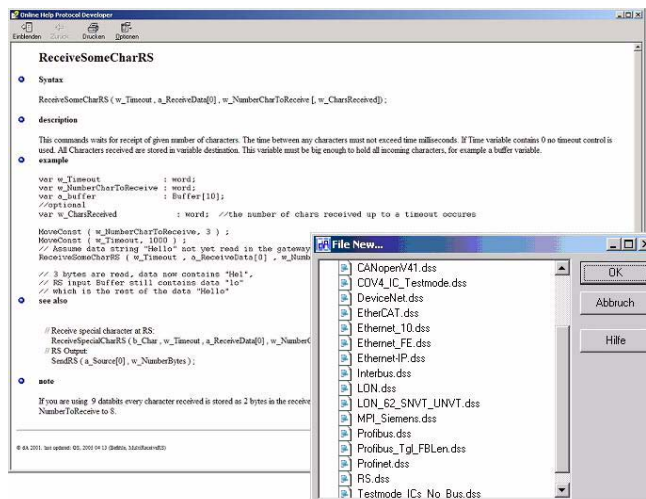

Picture 5: Online help

## Support

The PROTOCOL DEVELOPER has a context-sensitive help function, that provides an extensive description of each Script command.

Templates for different tasks and bus versions can directly be taken over and adjusted to your requirements.

Picture 6: Extract of the templates

## Example Scripts

For each Script command the scope of delivery of the free PROTOCOL DEVELOPER also includes a commented example Script. More support is available from our free Hotline and on our website the current versions of our instruction manuals and the software tools are also available free of charge ([www.deutschmann.de](http://www.deutschmann.de)).

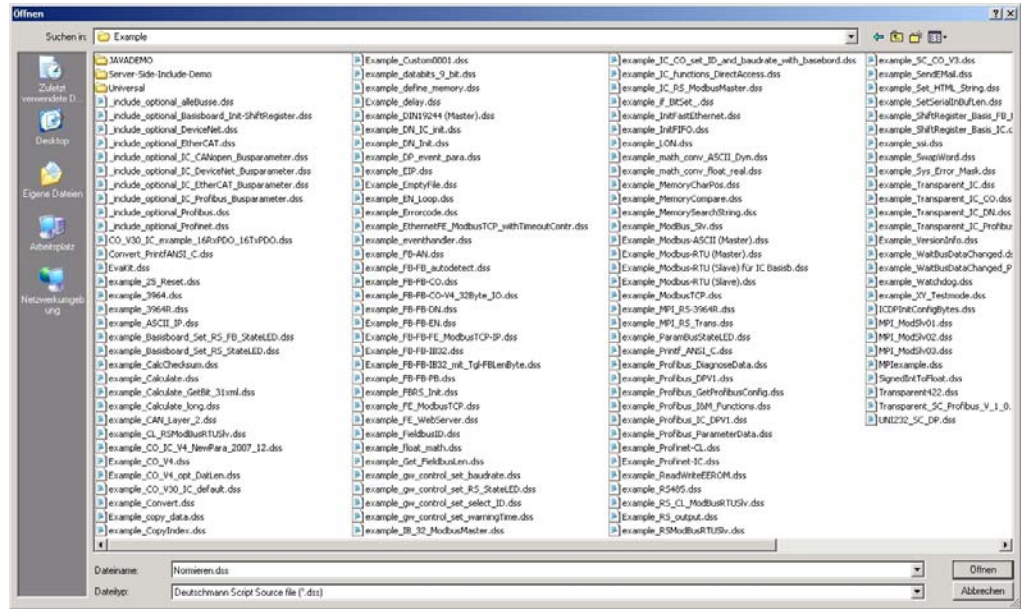

Picture 7: Extensive library for example Scripts

## That speaks for the Script language by Deutschmann:

- No changes required in your own Firmware
- Flexible and powerful Script language; especially generated for the bus communication
- Easy to handle. Based upon current tools, such as C++
- On request customized commands, e. g. in case functions are missing or an optimization is required for time-critical applications
- You can generate the Scripts yourself or Deutschmann is also offering the Script-generation as service
- Extensive support by means of help functions, templates, examples, hotline and workshops
- In the initial state devices can already be equipped with your Script

## UNIGATE® IC Developer-Board

The Developer Board was developed so that the fast implementation of the Deutschmann All-in-one bus node UNIGATE® IC into your electronic system can be guaranteed. The board is suitable for all Fieldbuses and Industrial Ethernet Buses supported by Deutschmann Automation. The required UNIGATE® ICs are ordered separately. The required voltage (5V or 3.3V, depending on the version) can be adjusted.

An RS232-interface or a USB-connection is available for the connection to the PC (DEBUG-interface). In case of the USB-connection the board is already supplied with voltage through it.

The application can be connected either through the USB, RS232, RS485 or the RS422. The bus connections according to standard or market standard are available to test the prevailing bus-side. Optionally Deutschmann Add-on packages (Bus-master simulation) are available.

The board contains 32 bit input and 16 bit output, provided with one LED each. Different connectors allow an easy coupling to your processor. A hole matrix field with the most important signals (voltage, IOs) allows a customized hardware extension (e. g. to connect a D/A converter).

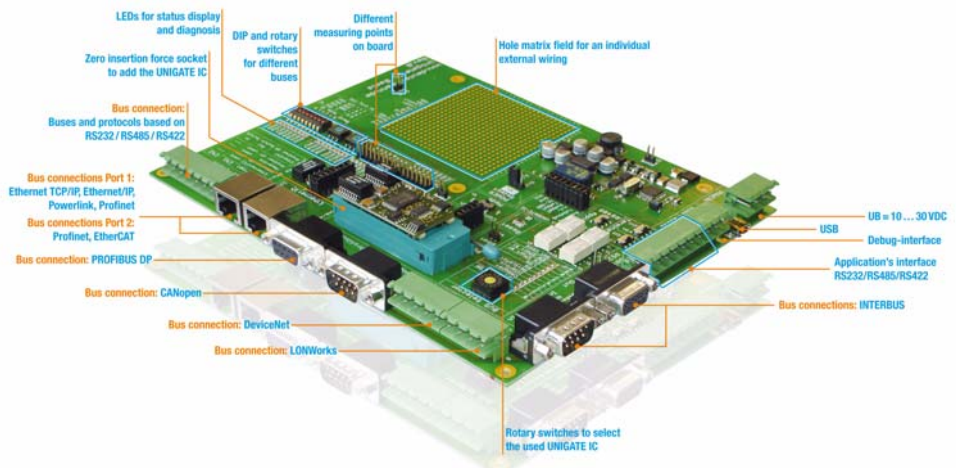

## That speaks for the Developer Board UNIGATE® IC by Deutschmann:















- One board for all offered Fieldbus- and Industrial Ethernet-versions of the Deutschmann UNIGATE® ICs
- Suitable for all versions (different voltage etc.)
- Integrated IOs
- Customized expansions via hole matrix possible
- Connectors for an easy coupling to your own processor

You receive the configuration tool WINGATE, the Protocol Developer for Script generation as well as extensive Script examples, device description files and much more free of charge. For further information and the mentioned tools please log on to our website [www.deutschmann.com](http://www.deutschmann.com)

### General technical data for all versions

• Housing	32 DIL
• Dimensions	45 x 25 mm (L x D) bus-specific
• Interfaces	2 x UART + 1 x shift register
• Baud rates of the serial interfaces	50 Baud up to 625 Kbaud, partially up to 2 Mbaud
• Input buffer RS-side	UNIGATE® IC: 1024 bytes input- and output-buffer each
• Diagnosis	LED-output
• Operating voltage	5 Volt/3.3 Volt (partially)
• Temperature range	Industrial temperature range from - 40°C up to + 85°C
• Certificates	Bus certification if possible
• Galvanic division	On the Fieldbus side for all bus versions
• RS- and bus-parameters	Adjustable via Script

### Bus-specific technical data

UNIGATE® IC	Bus data	Bus baud rates	UNIGATE® IC	Bus data	Bus baud rates
 CANopen	255 bytes I/O	1 MBit/s, 500 kBit/s, 250 kBit/s, 125 kBit/s	 LonWorks	62 NVT/s	78,1 kBit/s
 DeviceNet	255 bytes I/O	500 kBit/s, 250 kBit/s, 125 kBit/s	 Modbus TCP	1024 bytes I/O	10/100 MBit/s
 EtherCAT	1486 bytes I/O	100 MBit/s	 MPI	240 bytes I/O	Ajustable via Script
 Fast Ethernet 10/100 Mbit	1024 bytes I/O	10/100 MBit/s	 Profibus	96 bytes I/O 244 bytes I/O	Automatic up to 12 Mbaud
 Ethernet/IP	500 bytes I/O	100 MBit/s	 Profinet I/O-RT	1500 bytes I/O	100 MBit/s
 Ethernet Powerlink	1541 bytes I/O	100 MBit/s	 RS, (Modbus RTU, RK512, 3964R...)	512 bytes I/O	Adjustable via Script
 Interbus	8 bytes I/O 32 bytes I/O	500 kBit/s, 2 MBit/s		Developer Board for all offered UNIGATE® IC-versions	

More types are available within the respective bus-versions, e. g. 5V-versions, 3.3V-versions, with or without Profibus driver (RS485) or versions for those modules based on Ethernet with or without transformer. Since this brochure cannot always be adapted to new versions, details are not mentioned at this point.

PO Box 1108 - D-65516 Bad Camberg - Phone +49-(0)6434-9433-0 - Fax +49-(0)6434-9433-40 - e-mail: [info@deutschmann.de](mailto:info@deutschmann.de) - [www.deutschmann.com](http://www.deutschmann.com)